

Installation and Operating

ADU 190(t) 1/2 min and ADU 190(t) S 1/2 min Movement for Activ-DCF drive

Please read this instructions carefully before installation.



References to the User's Manual

1. The information in this User's Manual can be changed at any time without previous notice. The current version is available for download on www.mobatime.com – Downloads.
2. This User's Manual has been composed with utmost care, in order to explain all details in respect of the operation of the product. Should you, nevertheless, have questions or discover errors in this Manual, please contact us.
3. We do not answer for direct or indirect damages, which could occur, when using this Manual.
4. Please read the instructions carefully and start the setting-up of the product, only once you have correctly understood all information for the installation and of the operation.
5. The installation must only be carried out by skilled staff.
6. It is prohibited to reproduce, to store in a computer system or to transfer this publication in a way or another, even part of it. The copyright remains with all the rights with MOSER-BAER AG, CH-3454 Sumiswald / Switzerland.

Content

1. Dimensions, Definitions	4
2. Function description	5
3. Mounting guidelines	5
3.1 Mounting of movement series 190(t) S.....	5
3.2 Mounting of hands and starting-up	5
3.2.1 Mounting of hands	5
3.2.2 Starting-up and check of the hand position	6
4. Setting up / Connections	6
5. Technical specification	7

1. Dimensions, Definitions

Diameter	Type	Art.-No.
30 - 80 cm	Movement: ADU 190 ½ Min	202931
30 - 80 cm	Movement: ADU 190t ½ Min	202913
30 - 80 cm	Movement: ADU 190 S ½ Min	202930
30 - 80 cm	Movement: ADU 190t S ½ Min	202914

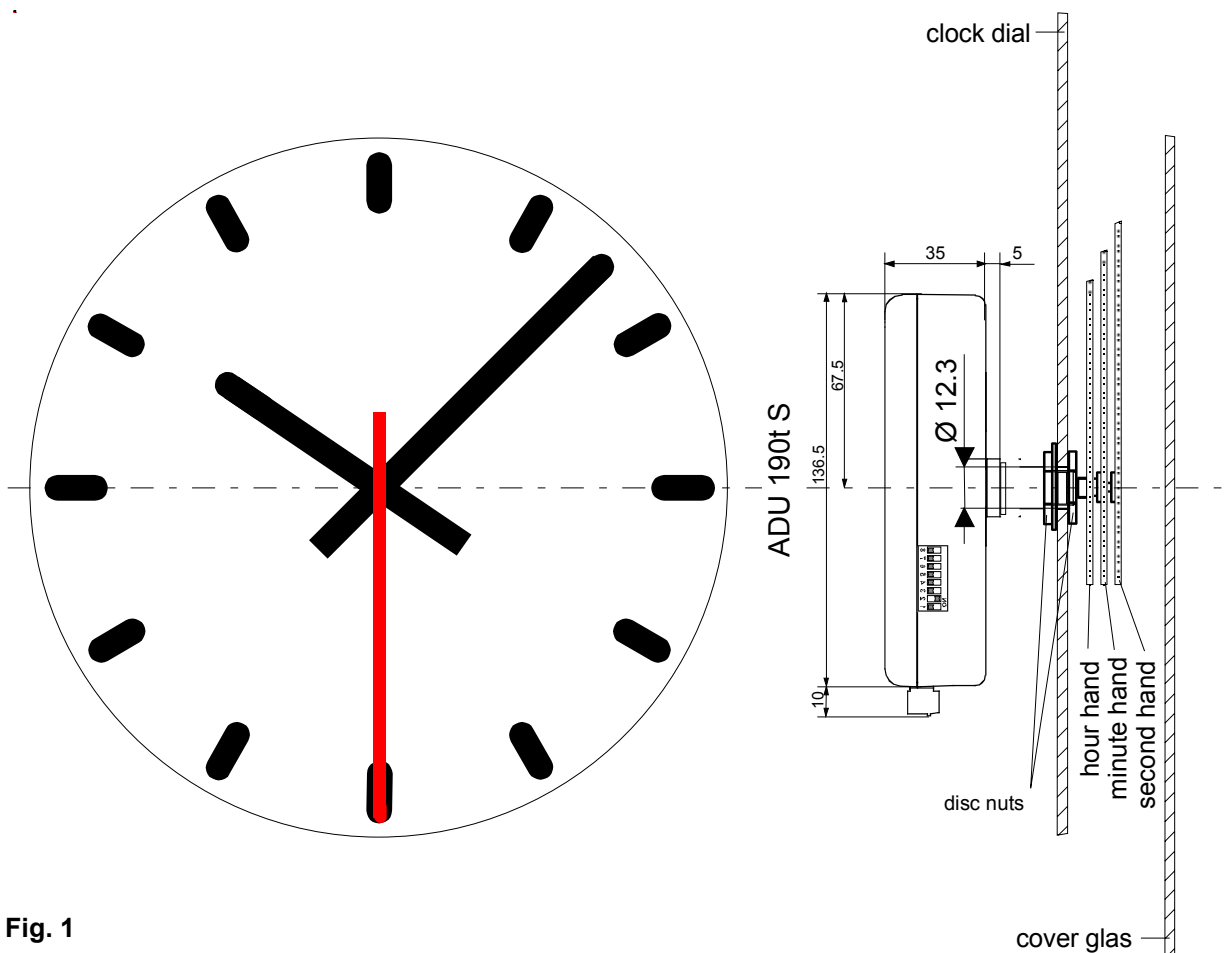

Fig. 1

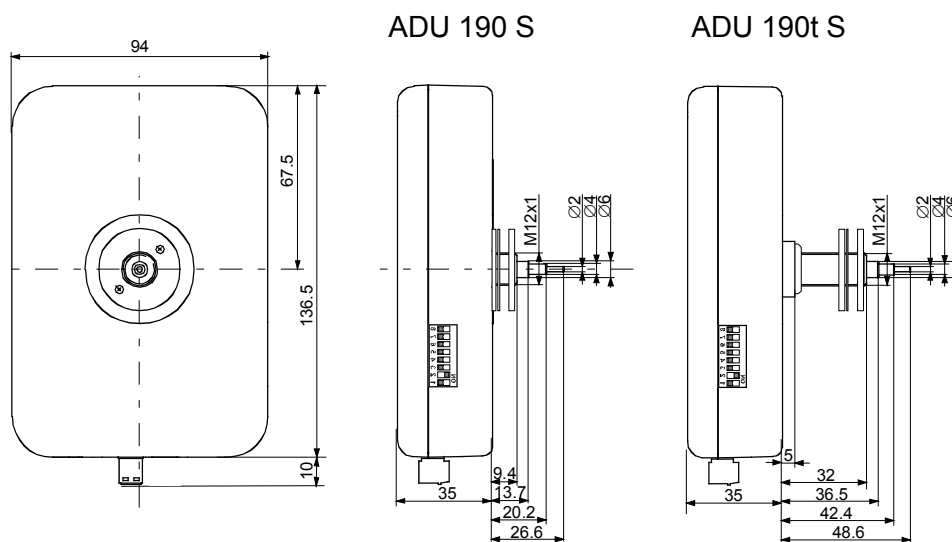

Fig. 2

2. Function description

Self-setting movement with hour, minute and second display. For autonomous self-setting clocks for indoor or outdoor use with dial diameters up to 80 cm, with or without illumination.

- **Active-DCF** time code controlled with automatic time take-over and daylight saving time take-over by means of the connected master clock.
- Appropriate to a combination of 24V impulse driven clocks.
- Operating mode selectable by means of a DIP switch.
- Signalization of missing time signal after 7 days by setting the hands to 12 o'clock position.
- Upon mains power failure, the movement will keep on running by battery-less running reserve up to 5 minutes, respectively 2,5 minutes with movement for ½ minute steps.
- Immediate resetting to the correct time after mains failure of up to 12 hours due to an internal real-time-clock (battery- less powered).
- Different running modes of the second hand, selectable by means of DIP-switch 2 and 3 (Fig. 6).
 - Switch 2: Continuous or secondly pace shift (wobbling).
 - Switch 3: 1 revolution in 58 s with stop at 12.00 and start with the minute change or no stop.

3. Mounting guidelines

3.1 Mounting of movement series 190(t) S

The dial must be sufficiently stable. The fixing hole must have a diameter of 12.3 mm.

The movement must be fixed in vertical position.

Vide Fig. 3 for the position of mounting parts.

The disc nut (2*) M12 x 1 has to be tightened with a special wrench tool (Art. No. 36761) and a torque wrench with a torque of 4.5 Nm +/- 0.2 Nm.

Attention:

The ring nut (5), the compensation ring (6) and the spring washer (7) must not be removed.

After tightening of the disc nut (2*), the movement must not be wrenched!

3.2 Mounting of hands and starting-up

3.2.1 Mounting of hands

The shafts of the hour, minute and second hands are positioned ex-work on the reference position (12 o'clock). The hands shall be carefully fixed and tightened on the shafts. Enough space must be provided between the hands. See Fig. 4.

The position 12 o'clock must be checked on each movement after the mounting (Chap. 3.2.2).

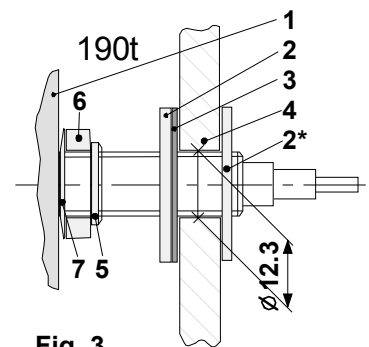

Fig. 3

- 1 Movement
- 2 Disc nut
- 3 Rubber washer
- 4 Dial
- 5 Ring nut
- 6 Compensation ring
- 7 Spring washer

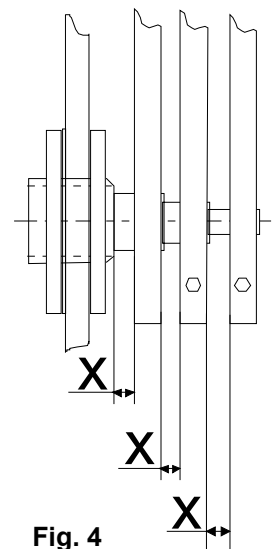

Fig. 4

3.2.2 Starting-up and check of the hand position

- Set DIP switch 1 to **ON** position (12:00 Position, Fig. 6, 7)
- Connect clock line signal (Active DCF) to the "Active DCF" connector (Fig. 5).
The clock runs to 12 o'clock position
→ Position of hands OK?
- If the hand position is wrong, carefully loosen the hand, adjust and tighten.
→ Check the 12 o'clock position again (initialising by an interruption of the power supply).
- If hand position OK, continue with chapter 4 for further setting up.

4. Setting up / Connections

- After checking the 12 o'clock position, reset DIP Switch 1 to **OFF** position (Fig. 6, 7).
- The hands remain max. 3 minutes in 12 o'clock position, until 2 complete telegrams are received.

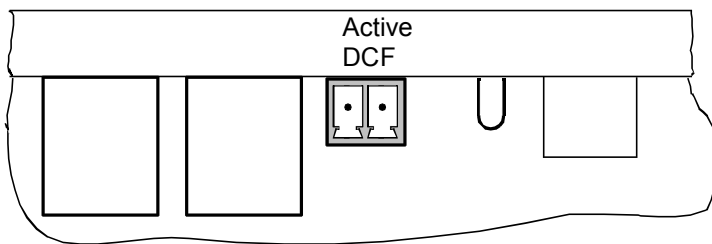

Fig. 5

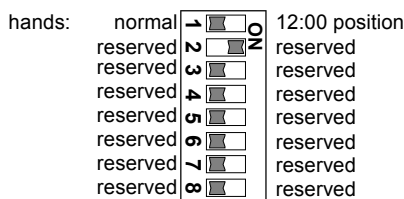

Fig. 6 (ADU 190)

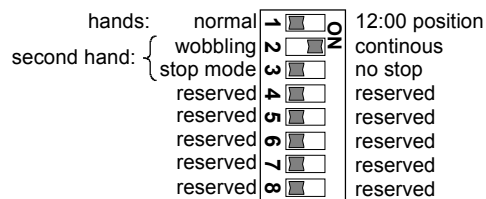

Fig. 7 (ADU 190 S)

Example:

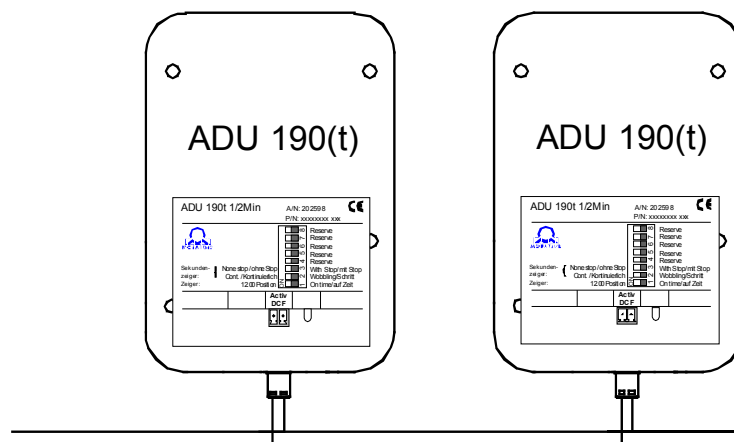

Fig. 8

ActiveDCF

5. Technical specification

	ADU 190 1/2Min	ADU 190t 1/2Min
Synchronisation	Active-DCF	
Setting times:		
Running time to reference pos.	max. 12 minutes	
Read in of time telegram	3 – 5 minutes	
Running time for new adjustment	< 12 minutes	
change of daylight saving time	< 11 minutes	
Operation mode minute shaft	1 step every 30 s	
Operation mode hour shaft	continuous	
Operation voltage (active-DCF line)	20 – 30VDC	
Power consumption	max. 20 mA	
Stand-by reserve (hour / minute)	at least 2.5 Min.	
Number of motors	1 (h. / min.)	
Dial diameter	25 – 80 cm	
Max. dial thickness	4 mm	14.5 mm
Temperature range	-30 ... +70°C	
Weight	320 g	360 g
Standards	EN 50121-4, EN 61000-6-3, Protection class II	

	ADU 190 S 1/2Min	ADU 190t S 1/2Min
Synchronisation	Active-DCF	
Setting times:		
Running time to reference pos.	max. 12 minutes	
Read in of time telegram	3 – 5 minutes	
Running time for new adjustment	< 12 minutes	
change of daylight saving time	< 11 minutes	
Operation mode second shaft	<ul style="list-style-type: none"> - Continuous or secondly pace shift (wobbling) - 1 revolution in 60 s or 1 revolution in 58 s with stop at 12.00 and start with the minute change 	
Operation mode minute shaft	1 step every 30 s	
Operation mode hour shaft	continuous	
Operation voltage (active-DCF line)	20 – 30VDC	
Power consumption	max. 35 mA	
Number of motors	2 (Std. / min. + sec.)	
Stand-by reserve	At least. 2.5 min. (hour / minute) / 0 min. (seconds)	
Dial diameter	25 – 80 cm	
Max. dial thickness	4 mm	14.5 mm
Temperature range	-30 ... +70°C	
Weight	340 g	380 g
Standards	EN 50121-4, EN 61000-6-3, Protection class II	

Technical data subject to change without notice

www.mobatime.ch



SALES SWITZERLAND

MOBATIME SWISS AG

Stettbachstrasse 5 • CH-8600 Dübendorf
Tel. +41 44 802 75 75 • Fax +41 44 802 75 65
info-d@mobatime.ch • www.mobatime.ch

MOBATIME SWISS SA

En Budron H 20 • CH-1052 Le Mont-sur-Lausanne
Tél. +41 21 654 33 50 • Fax +41 21 654 33 69
info-f@mobatime.ch • www.mobatime.ch

SALES WORLDWIDE

MOSER-BAER SA – EXPORT DIVISION

19 chemin du Champ-des-Filles • CH-1228 Plan-les-Ouates/GE
Tel. +41 22 884 96 11 • Fax. +41 22 884 96 90
export@mobatime.com • www.mobatime.com

PRODUCTION

MOSER-BAER AG

Spitalstrasse 7 • CH-3454 Sumiswald
Tel. +41 34 432 46 46 • Fax. +41 34 432 46 99
moserbaer@mobatime.com • www.mobatime.com



SALES GERMANY, AUSTRIA

BÜRK MOBATIME GmbH

Postfach 3760 D-78026 VS-Schwenningen
Steinkirchring 46 D-78056 VS-Schwenningen
Telefon +49 7720 8535 - 0 Telefax +49 7720 8535 - 11
Internet: <http://www.buerk-mobatime.de> E-Mail: buerk@buerk-mobatime.de